





ABITIG® GRIP Little 9, ABITIG® GRIP Little 20



ABITIG® GRIP 9, ABITIG® GRIP 20, ABITIG® GRIP 20 SC

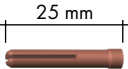
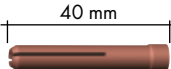

Slijtonderdelen

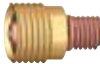

			
Toortskap	Kort	Midden	Lang
	701.0240 / 41V33	701.0244 / 41V35	701.0247 / 41V24

		
	25 mm	40 mm
Spantang	Standaard	Groot
Ø 0,5 mm	701.0249 / 13N20	701.1225 / 13N20L
Ø 1,0 mm	701.0250 / 13N21	701.1226 / 13N21L
Ø 1,2 mm	701.0254 / -	-
Ø 1,6 mm	701.0251 / 13N22	701.1227 / 13N22L
Ø 2,0 mm	701.0255 / -	-
Ø 2,4 mm	701.0252 / 13N23	701.1228 / 13N23L
Ø 3,2 mm	701.0253 / 13N24	701.1229 / 13N24L

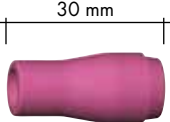
		
Isolator	Isolator	Adapterring
Adapterring	702.0055 / 598882	701.1234 / 54N63-20

			
Spantanghouder	Standaard	Gasverdelers	Uitvoering gasverdelers groot
Ø 0,5-1,0 mm	701.0275 / 13N26	701.0301 / 45V42	701.1230 / 45V0204S
Ø 1,2 mm	701.0279 / -	701.0313 / -	-
Ø 1,6 mm	701.0276 / 13N27	701.0307 / 45V43	701.1231 / 45V116S
Ø 2,0 mm	701.0280 / -	701.0315 / -	-
Ø 2,4 mm	701.0277 / 13N28	701.0309 / 45V44	701.1232 / 45V64S
Ø 3,2 mm	701.0278 / 13N29	701.0311 / 45V45	701.1233 / 995795S

			
	30 mm	25,5 mm	48 mm
Keramisch gasmondstuk	Standaard	Standaard	Uitvoering gasverdelers groot
No. 4 Ø 6,5 mm	701.0281 / 13N08	701.0317 / 53N58	-
No. 5 Ø 8,0 mm	701.0282 / 13N09	701.0318 / 53N59	-
No. 6 Ø 9,5 mm	701.0283 / 13N10	701.0319 / 53N60	701.1199 / 57N75
No. 7 Ø 11,0 mm	701.0284 / 13N11	701.0320 / 53N61	-
No. 8 Ø 12,5 mm	701.0285 / 13N12	701.0322 / 53N61S	701.1200 / 57N74
No. 10 Ø 16,0 mm	701.0286 / 13N13	-	701.1201 / 53N88
No. 12 Ø 19,5 mm	-	-	701.1121 / 53N87

		
	X1	34 mm
Keramisch gasmondstuk	Standaard	Uitvoering gasverdelers groot***
No. 4 Ø 6,5 mm 48 mm	701.0289 / 796F71	701.1202 / 53N89
No. 5 Ø 8,0 mm 48 mm	701.0290 / 796F72	
No. 6 Ø 9,5 mm 48 mm	701.0291 / 796F73	
No. 4 Ø 6,5 mm 63 mm	701.0293 / 796F75	
No. 5 Ø 8,0 mm 63 mm	701.0294 / 796F76	
No. 4 Ø 6,5 mm 89 mm	701.0296 / 796F79	

***Niet geschikt voor HF